



Operating Instructions

Issue No. 5
Sheets 39



Automatic Creasing, Perforating and Punching Machine

AIRSPEED 450

Attention

This document including its appendices is exclusive intellectual property of Cyklos (producer cooperative) Choltice. Any other use (copying, distribution or sale) is possible only with approval of the chairman of the cooperative.

Valid from serial number:

202134664
(version D)

CONTENTS

1. Introduction.....	4
2. Safety Risks.....	4
2.1 Warning.....	4
2.2 General Work Safety and Health Protection	4
3. Warnings	5
4. Technical Parameters.....	7
5. Machine Description	8
5.1. Introduction	8
5.2 Exchangeable tools	9
6. Machine Installation	11
7. Setting the Machine	11
7.1 Setting the Guides.....	11
7.2 Setting the Separator	13
7.3 Setting Rotary Perforating (Cutting) and Guiding Pulleys	14
7.3.1 Setting Perforation or Cutting Thrust.....	15
7.4 Setting Delivery Table	15
7.5 Adjustment of Top Bar Stroke.....	15
8. Setting the Machine Using Touch Screen	17
8.1 Touch Screen Preview	17
8.2 Overview of Touch Screen Function Icons	17
8.2.1 Sound On/Off.....	17
8.2.2 Manual Control	18
8.2.3 Info	18
8.2.4 Language Selection	18
8.2.5 Service Menu.....	19
8.3 Setting the Feed.....	20
8.4 Setting the Number and Position of Creases/Perforations	21
8.4.1 Most Common Folds.....	21
8.4.2 Setting the Number of Segments	22
8.4.3 Setting the Position of Segments	22
8.5 Setting the Speed of Processing	23
8.6 Loading Paper.....	23
8.7 Setting Batch.....	23
8.7.1 Total Batch	23
8.7.2 Partial Batch	24

8.8 Program Saving and Loading 24

8.9 Starting Working Cycle 25

 8.9.1 Working Screen 26

8.10 Manual Control..... 27

 8.10.1 Rotary Perforating, Cutting..... 27

 8.10.2 TriFold 360 Connection..... 27

9. Recommended Machine Maintenance 28

10. Machine Disposal 28

Appendix 1: Accessories..... 29

Appendix 2: Table Assembling Instructions..... 33

Appendix 3: Optional Accessory 34

 3.1 Strike Tools 34

 3.1.1 Removing Punching Tool Pins 35

 3.2 Rotary Tools..... 36

Appendix 4: Ultrasound Set for Double Sheet Detection 37

Appendix 5: The Most Common Faults (Troubleshooting) 38

1. INTRODUCTION

We are presenting you with Operating Instructions that contain machine technical data and instructions necessary for the correct setting, start-up, operation and maintenance of the machine.

The Operating Instructions are intended for machine operators as well as for service engineers. The individuals manipulating, installing and operating the machine should familiarise themselves with the instructions before they start. We would like to emphasise that service operations may only be executed by authorised individuals with proper qualification. They should be thoroughly familiar with the control and all functions of the machine. Any repair done without authorisation may render the warranty null and void. Reference is made to Section 2.2 – Work Safety and Health Protection providing basic information about safe use of the machine and operator's health protection. Please pay due attention to this section. Be aware that the final responsibility lies with the individuals working with the machine.

The machine construction complies with Directive 98/37/EC of the European Parliament and of the Council. If all the instructions in this document are respected, the machine will render satisfactory and precise performance.

We can assure you that the machine has received maximum care. Thoroughness of control ensures machine precision within the scope of the acceptance standards applicable to this machine. We believe these Operating Instructions will be a valuable guide for you.

2. SAFETY RISKS

2.1 Warning

When using AirSpeed 450, all safety rules and procedures as well as all warnings regarding work safety and health protection listed in this document must be observed. Otherwise, considering the bellow listed factors, a serious injury or death of a person, damage or destruction of the machine, its parts or accessories could occur.

Factors increasing risk:

- Rotating pulleys and moving belts
- Voltage
- Noise made during processing
- Moving parts of the machine and equipment
- Sharp edges created during processing
- Dust created during processing

2.2 General Work Safety and Health Protection

This section provides the user with basic information about work safety and health protection of the operator and any other individuals who come into contact with the machine.

If the AIRSPEED 450 is used correctly, it is a very safe machine. However, if used incorrectly, it can be dangerous. When operating the machine, the operator is responsible for their own personal safety. The manufacturer may not be held liable for any personal injury or damage to the machine caused by use or operation at variance with these Operating Instructions. The owner of the machine is responsible for the machine being operated, maintained and serviced only by qualified personnel.

The machine design is in compliance with international standards and regulations for construction of machine tools. For the machines exported to the European Economic Area (EEA), the customer will obtain a "**Declaration of Conformity**" together with the accompanying technical documentation for the machine - Operating Instructions. Also, the machine bears the CE marking.

The CE marking on the machinery signifies that the product complies with the technical requirements specified in all the legal regulations that apply to the machinery and that require or allow this marking. This marking also signifies that a specified procedure was followed during the assessment of the stated conformity.

The manufacturer certifies by means of the "Declaration of Conformity" that the machinery concerned complies with the requirements of Directive 98/37/CE of the European Parliament and of the Council and those of the harmonised technical standards. Directive 98/37/CE of the European Parliament and of the Council is a document defining the generally applicable basic requirements for health protection and safety of machinery operated at the user's facility within the EEA.

Directive 98/37/CE of the European Parliament and of the Council does not apply to the machinery exported to countries outside the EEA.

The customer will receive the accompanying technical documentation for the machine – Operating Instructions. The manufacturer hereby requests that the user trains its staff accordingly in order to ensure comprehensive safety as directed by the relevant laws, standards and regulations, these Operating Instructions and other documents.

The machine is intended for work in automatic cycles.

The machine operator monitors the process and the operating mode of the machine, replacing material and checking the dimensions. The Operator's position by the machine is not defined.

3. WARNINGS

Only sheets of the size listed in the parameters can be creased and perforated in the creasing and perforating machine.

- a) The operator or the individual appointed for operation cannot use the machine unless they have been trained.
- b) It is forbidden to crease and perforate foils, sheet metal or other similar materials.
- c) The machine can be only used in enclosed spaces (e.g. offices, shops).
- d) It is forbidden to use the machine outdoors.
- e) It is forbidden to use the machine when the electric cord is damaged.
- f) It is forbidden to use the machine if it makes strange sounds.

- g) It is forbidden to connect the machine to voltage different from that indicated on the manufacturer's identification plate.
- h) Read all instructions before using the machine.
- i) Keep the children away from the machine.
- j) It is forbidden to put fingers or hands into the machine when the electric cord is plugged in.
- k) Do not replace faulty electrical components with components of different type or different capacity. When replacing a component, the electric cord must be unplugged.
- l) Covers can be only dismantled by trained personnel when the machine is unplugged.
- m) The operator must pay special attention during manipulation with rotary parts of the machine – see yellow Warning Sign (Pos. 40, page 9) – **DO NOT OPEN/REMOVE SAFETY COVER UNTIL MACHINE STOPS**



4. TECHNICAL PARAMETERS

a)	Working width	115 – 456 mm, min. sheet size 115 x 130 mm
b)	Recommended paper grammage	80 – 400 g/m ² (creasing, punching) 80 – 250 g/m ² (perforating)
c)	Crease width*	CITO 1.0 mm – paper thickness < 0.4 mm (recommended grammage 80 – 200 g/m ²) “Iron Channel” 1.9 mm – paper thickness 0.4 – 0.5 mm (recommended grammage 200 – 400 g/m ²)
d)	Min./max. number of creases per sheet	0/40
e)	Max. number of perforating wheels	13 (for more info refer to Appendix 3)
f)	Number of programs	60
g)	Min./max. distance between creases	1/999 mm
h)	Min. distance of crease from front edge	0 >
i)	Speed	3.000 sheets A4/h (with single crease) 4.300 sheets A4/h (0 crease, only rotary perf./cutting)
j)	Input capacity	70 mm
k)	Machine dimensions	1.320 x 755 x 475 mm 1.320 x 755 x 1.225 mm (including table)
l)	Machine weight	net 140 kg, gross 188.5 kg (including mobile table)
m)	Voltage / frequency	50/60 Hz
n)	Power	400 W
o)	Fuse	T2 A / 250V
p)	Noise level	65 dB

**Note: Respect the recommended width of creasing channel for different paper thickness. If use inappropriate width of crease is used (usually narrow creasing channel for thick paper), inaccuracies in the position of crease may appear, resulting in the crease being placed at a distance different from what was set on the touch screen. If thick paper is used in combination with a narrow crease, it will result in the paper being pressed into the creasing channel, and the rollers starting to slip in an attempt to release the paper. Use wider crease channel in such case.*

5. MACHINE DESCRIPTION

5.1. Introduction

The electric automatic creasing and perforating machine serves for the processing of graphic material of up to 450 mm in width. The creasing allows for easy folding of the paper, thereby making the machine convenient for use in combination with a folding module. Waste-free perforation allows you to tear off the paper easily.

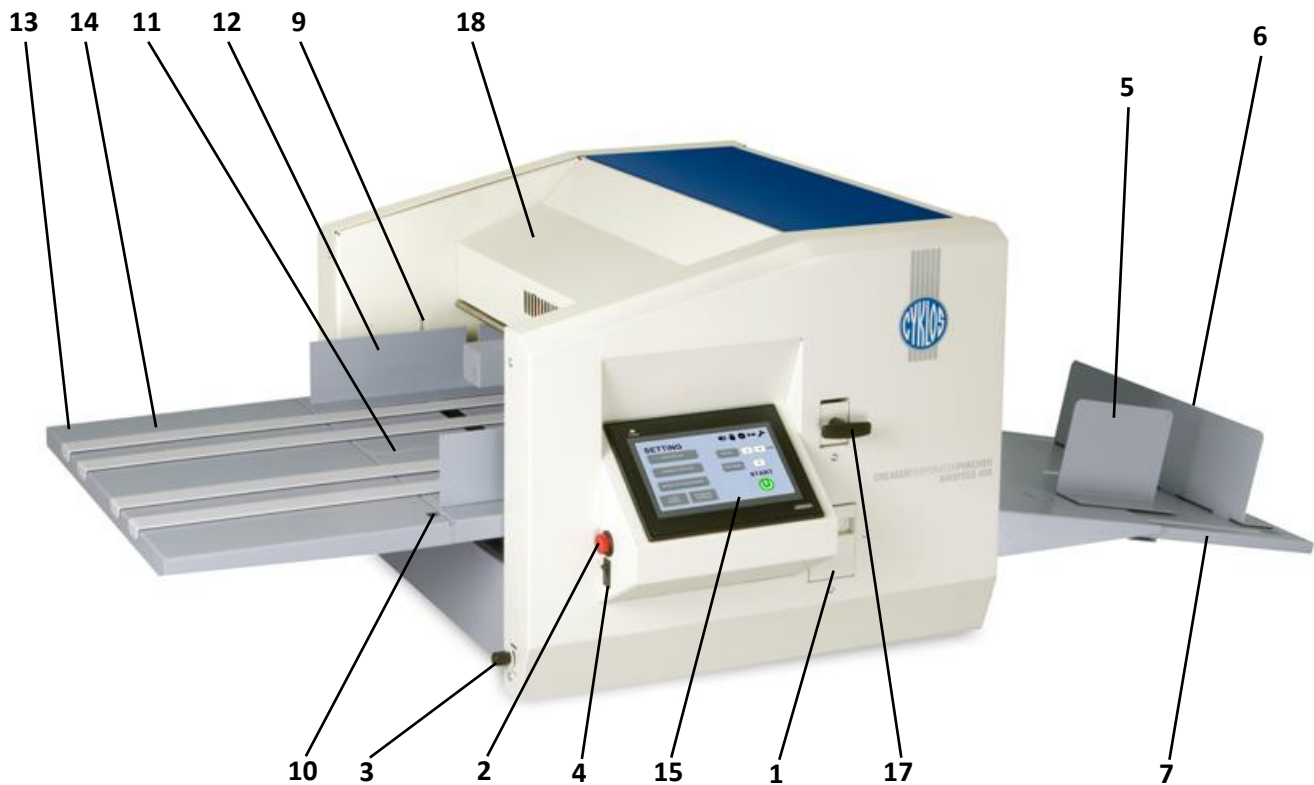

Fig. 1: View of the Machine

- | | |
|---|--|
| 1 – Waste drawer | 13 – Front auxiliary table |
| 2 – STOP button | 14 – Levelling strip |
| 3 – Separator position regulation screw | 15 – Touch screen |
| 4 – Electric switch | 16 – Ruler (Fig. 2) |
| 5 – Rear side guide | 17 – Exchangeable tool |
| 6 – Back stop | 18 – Front cover |
| 7 – Delivery table | 19 – Plug socket (Fig. 2) |
| 8 – Plug for TriFold 360 (Fig. 2) | 20 – Tool thrust regulation screw (Fig. 2) |
| 9 – Side guide lock | 21 – Needle bearing (Fig. 2) |
| 10 – Side guides turning screw | 22 – Safety ring (Fig. 2) |
| 11 – Front table | 23 – Top bar (Fig. 2) |
| 12 – Side guide | 24 – Top bar bearing (Fig. 2) |

- 25 – Guiding, perforating pulley
- 26 – Thrust pulley
- 27 – Rear upper cover
- 28 – Shaft

- 29 – Fixing sleeve
- 30 – Perforating (Cutting) kit
- 40 – Warning Sign

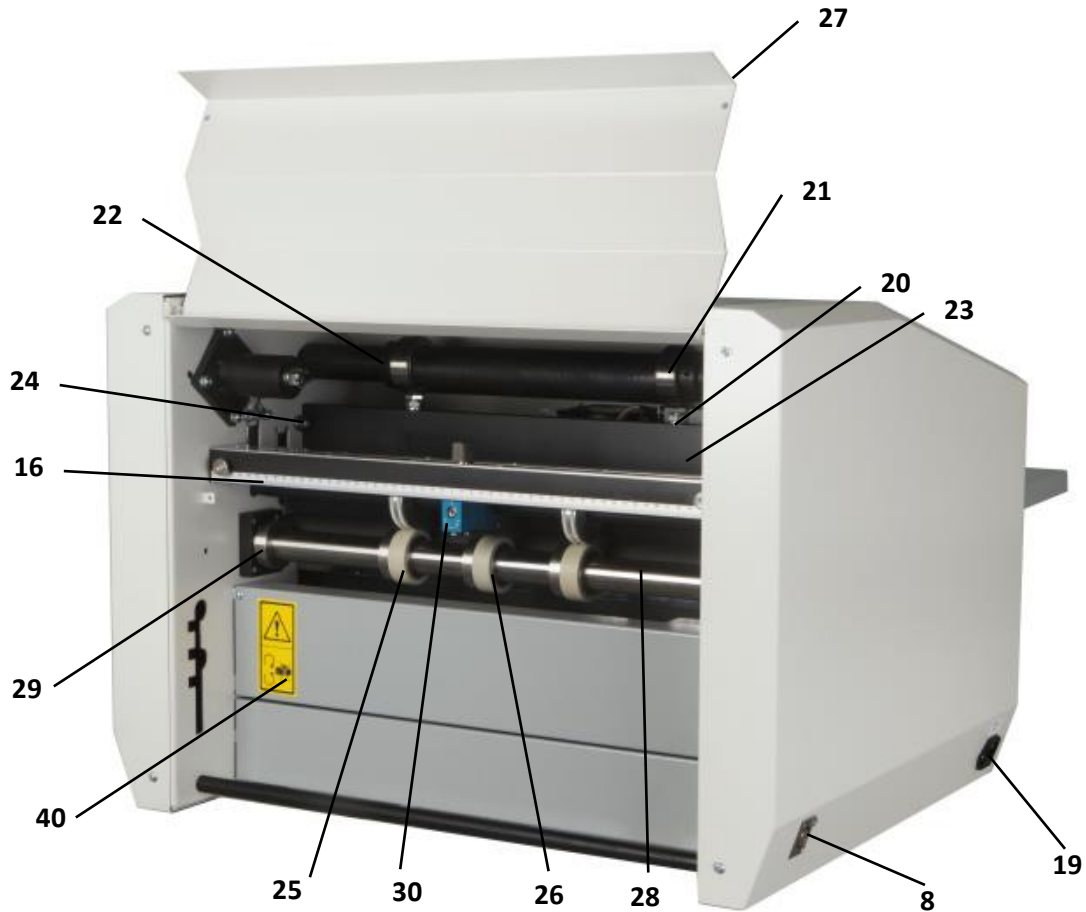

Fig. 2: Rear View of the Machine

5.2 Exchangeable tools

In standard equipment, the machine is supplied with the three exchangeable tools described below. Special tools, such as calendar semi-circle, are available as additional optional accessories (see Appendix 3).

The default setting has been done for all types of tools. A change of the machine function requires the tool to be replaced (placed by the manufacturer into the waste drawer – 1). Use the electric switch (4) to switch off the machine, slide out the tool (17) and put in the tool you wish to use.

Loosen the tool screws (31, 32, 33, 34) in order to replace the knives in the tools. Replace the knife and fit the tool back. Tighten the tool screws (33, 34). Do not overtighten the tool screws (31, 32). Then place the tool into the machine and perform a trial stroke (see Section 7.5) to ensure the knife and the tool base are parallel (35). Re-tighten the screws (31, 32). Now the tool is ready for use.

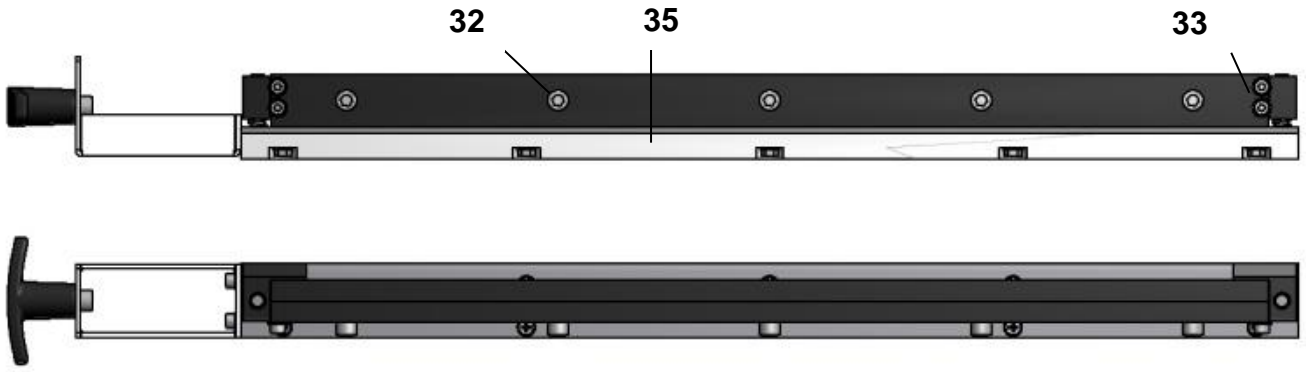

Fig. 3: Perforating tool 2:1- 9 TPI (571 40 465a) – standard equipment. Microperforating tool (571 40 464) as optional accessory.

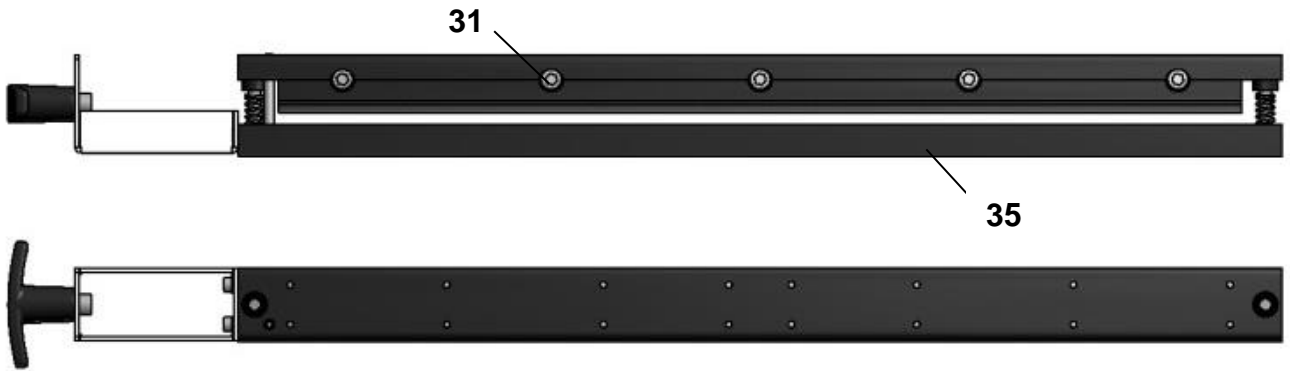

Fig. 4: Creasing tool CITO 1.0 mm (571 40 467) – standard equipment. Creasing tool CITO 1.4 mm (571 40 468) as optional accessory.

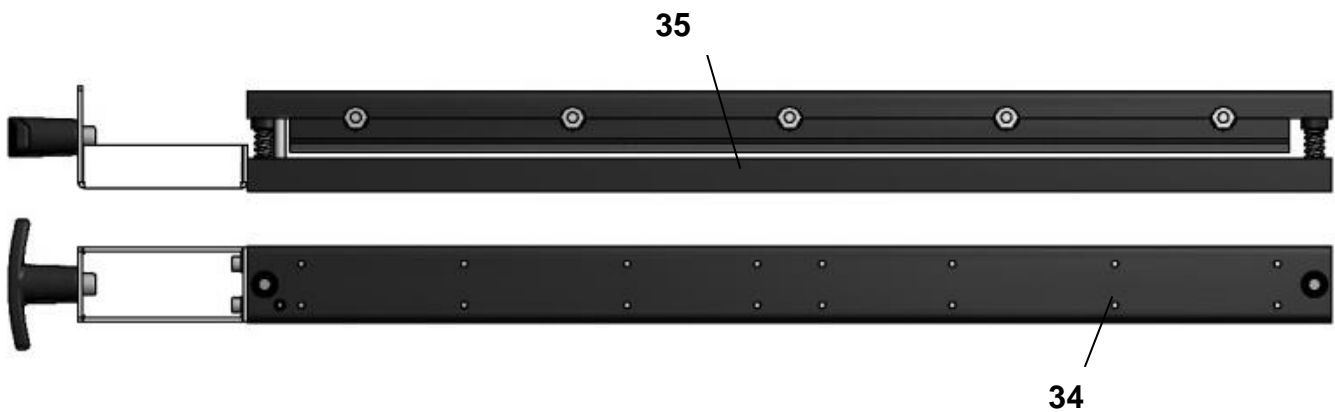

Fig. 5: Creasing tool – iron channel 1.9 mm for heavy grammage (570 40 466)

6. MACHINE INSTALLATION

Unpack the machine, take it out of the box and remove the four transport bolts at the base of the machine. Put the machine on the table (refer to Appendix 2 for the table assembly instructions) and use the screws (36) to attach it to the table. Once the machine is secured, mount the front auxiliary table (13) and the delivery table (7). When plugged in, the machine is ready to operate. When the electric switch (4) is switched on, the touch screen (15) will light up. Setting the machine by means of the touch screen is described in detail in Section 8.



Fig. 6: Machine installation on the table

7. SETTING THE MACHINE

7.1 Setting the Guides

Use the side guides turning screw (10) to set the side guides (12) perpendicularly with the tool. The side guides are set in the initial position (perpendicular to the tool) if the rear edge of the right side guide aligns with the feeding table line (fig. 7).

Note: It is recommended to set the side guide perpendicularity in the position as shown in Fig. 7. Besides the line parallel to the tools, the A2 position line may also be of assistance when identifying the correct side guide position (the A2 position line must be parallel to the side guide).

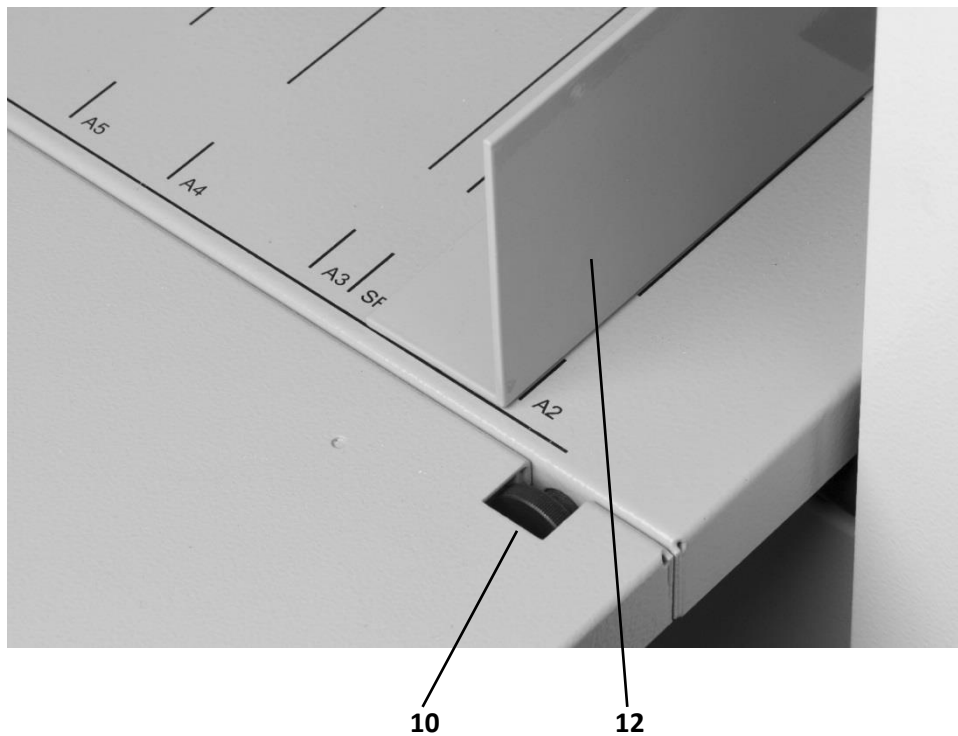

Fig. 7: Setting the Side Guides

Loosen the side guide lock (9). Set the side guides (12) approximately for the paper format size so that the position of the sheet is symmetrical with the centre of the table. The rulers on the feeding table serve for exact setting of the side guides (12). Place the levelling strips (14) on the feeding table between the front side guides (12) – two or four strips according to the paper format.

For proper feed operation, it is necessary to place the front stops (43a, 43b) behind the paper on the feed table. For correct distribution of large formats (A3 and larger) it is suitable to extend the guides (12) with additional side guides (37), Fig. (8a).

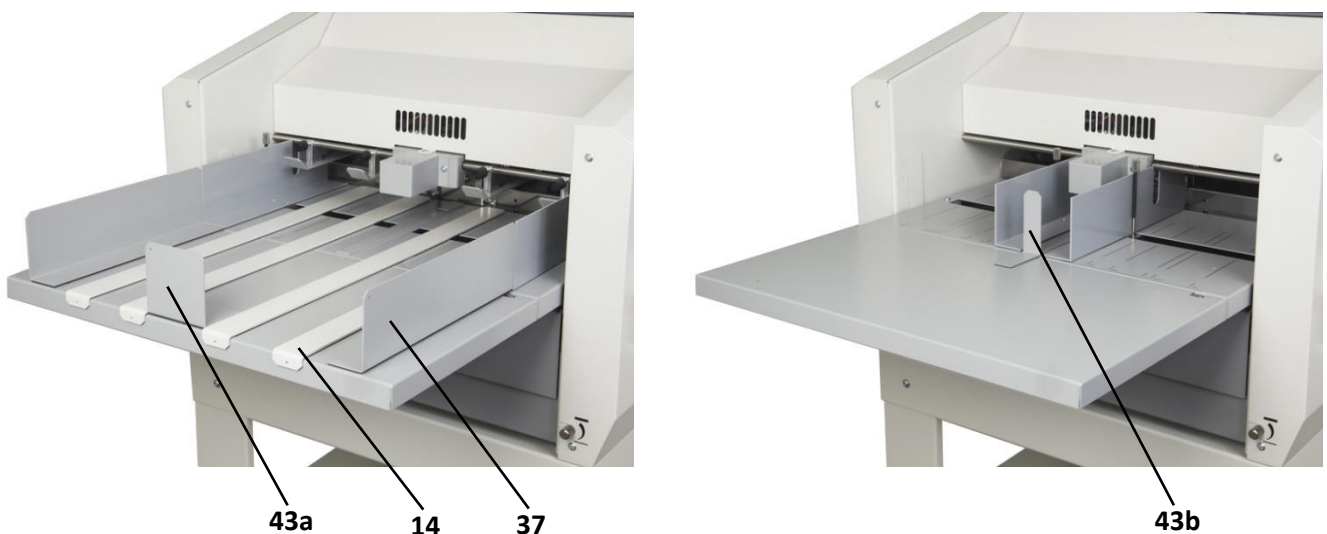

Fig. 8a: Levelling Strips, Side Guides set for maximum size and Additional Side Guides.

Fig. 8b: Side Guides set for minimum size

For better guidance of corrugated paper into the feed rollers, the upper guides (42a, 42b) can be used. Two or four pieces according to the paper size.

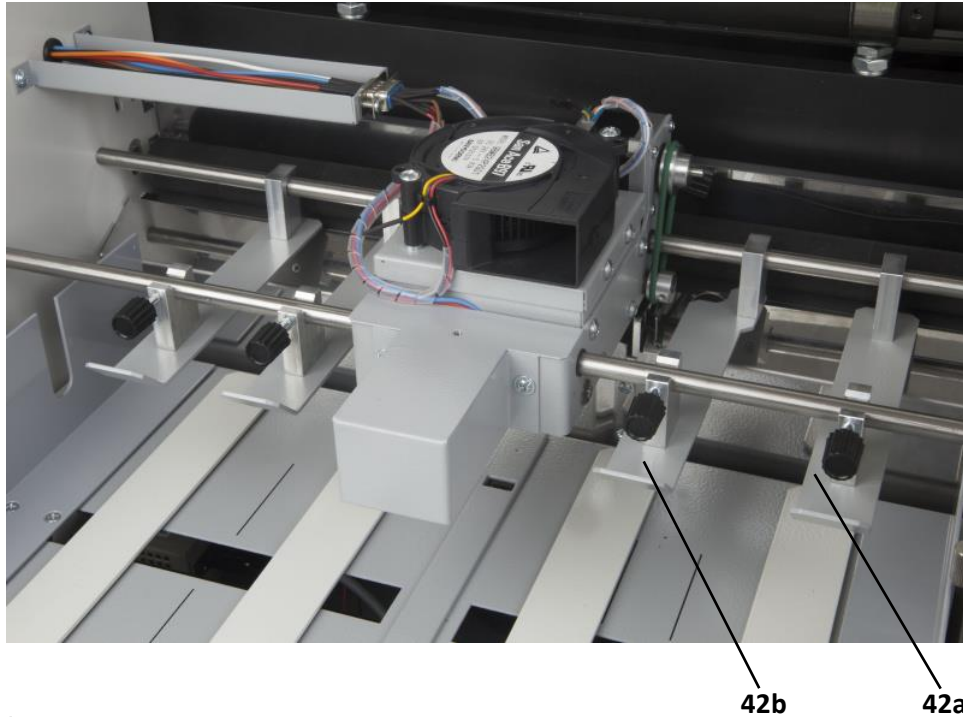

Fig. 9: Upper Guides

7.2 Setting the Separator

Set the separator position regulation screw (3) in the maximum position (open gap). Put a sample of the paper you wish to process in the gap between the separator (39) and the feeding head strips (38). Use your hand to move the sample to and fro, at the same time, use your other hand to tighten the separator position regulation screw until the paper can no longer move freely and light resistance is felt. Now carefully turn the screw back so that the paper can again move freely. This sets the optimum gap between the separator and the feeding head strip. You may want to move the feeding table to the lower position to get better access to the separator.

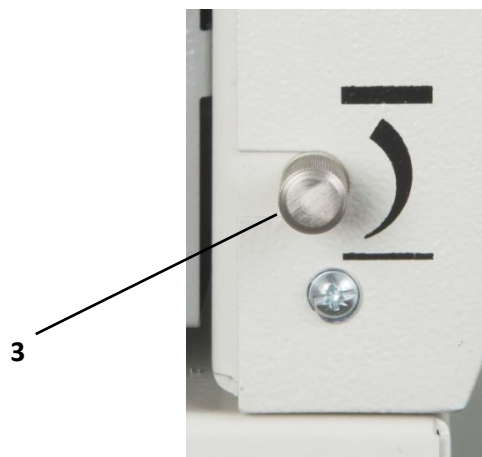

Fig. 10a: Regulation Screws of Separator Position

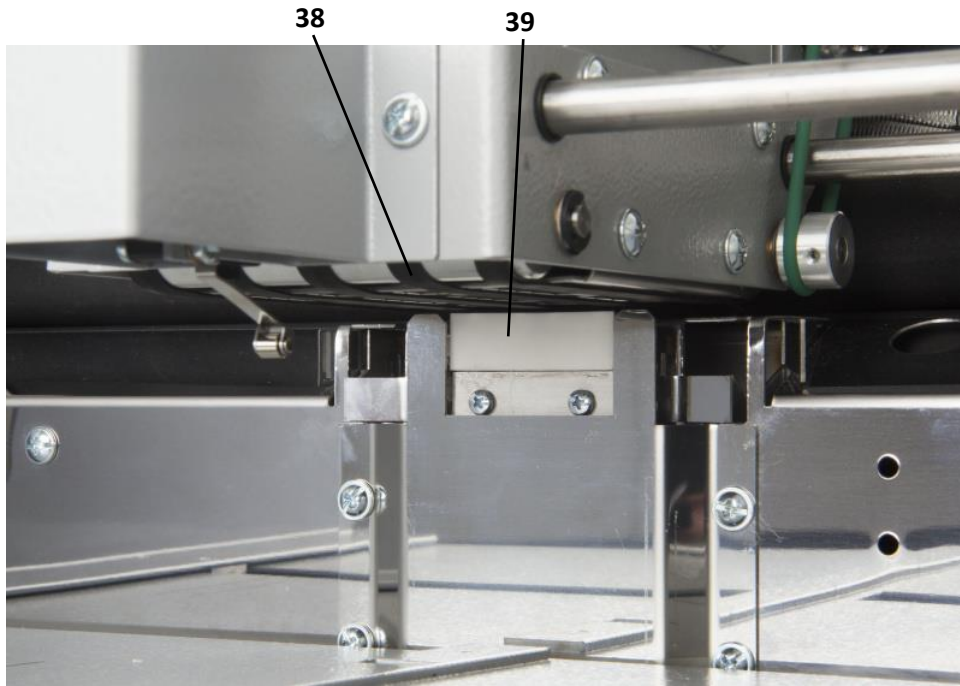

Fig. 10b: Separator and Feed Belts

7.3 Setting Rotary Perforating (Cutting) and Guiding Pulleys

Lift the rear upper cover (27) and use an Allen key to loosen the perforation pulley screws (25) in order to adjust the perforating or cutting wheels (30). Set the pulleys on the lower shaft in the required position and tighten up the screws. Then place the perforating wheel (30) in the required position and tighten up with the screw.

Alternatively, you may remove the whole shaft (28) and add or remove pulleys as required. In order to remove the shaft, use an Allen key to loosen the screw on the fixing sleeve (29 – Fig. 2) and push the sleeve aside. Then move the whole shaft to the left (in the direction of the side of the machine) and remove the shaft from the machine. Before you do so, make sure the perforating (cutting) wheels are placed in the non-working position!

Important information on setting the longitudinal perforation can be also found in chapter 8.10.1

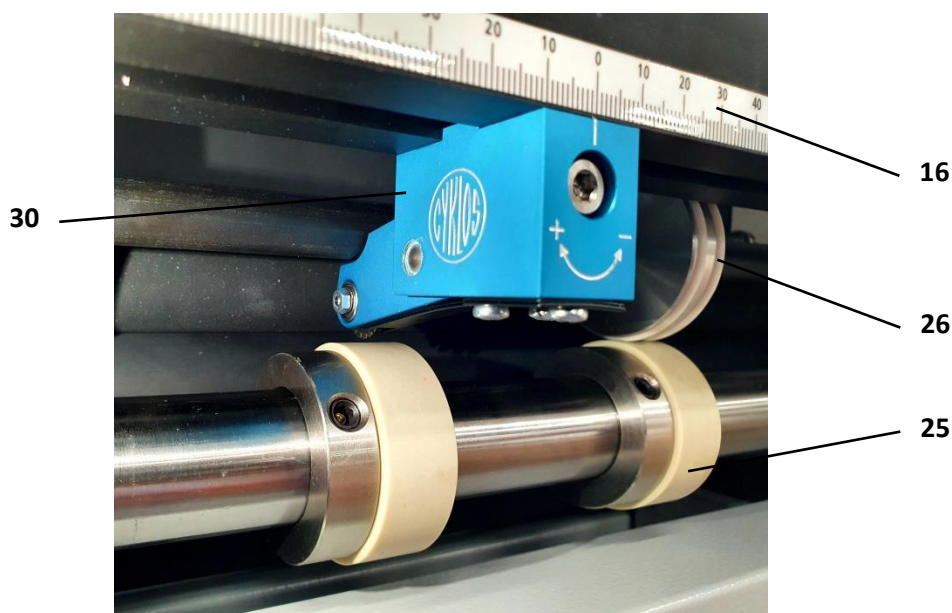

Fig. 11: Setting Rotary Perforating and Cutting

7.3.1 Setting Perforation or Cutting Thrust

Use an Allen key to turn the regulation screw of the perforating kit (30) to set perforation thrust.

Turn in the direction of + for higher thrust. Turn in the direction of - for lower thrust. It is recommended to set the lowest possible thrust as this will prolong the service life of the perforating pulley.

7.4 Setting Delivery Table



The delivery table (7) is telescopic and can be set in three heights, or removed from the machine.



Obr. 12: Nastavení zadního stolu

7.5 Adjustment of Top Bar Stroke

Unless the depth of a crease on both sides of the sheet is identical or unless the sheet is torn away evenly after perforation, the top bar (23) can be moved down using the tool thrust regulation screws (20). The screws should be loosened anticlockwise by approx. 30°, 1/12 of the revolution (the bar moves downwards) and then secure them with a nut. Try the quality of perforation after each turn of the screw by 30° and, if

satisfactory, do not turn the screws any more. When adjustment of perforation is finished, the machine is also to be adjusted for creasing. If the perforating/creasing force exceeds the limit (engine output is exceeded) and the top bar (23) remains in the lower position, use the electric switch (2) to switch the machine off and then wait for 20 seconds before you re-start the machine. Press  (Manual control – Section 8.10), then  (tool backwards) under the field **UPPER TOOL**. The tool is now unlocked and the thrust can be adjusted using the tool thrust regulation screws (20). Activate  (tool forwards) to make a trial stroke.

8. SETTING THE MACHINE USING TOUCH SCREEN

8.1 Touch Screen Preview



Fig. 13: Start-up Screen

When the electric switch (4) is turned on, the Start-up Screen (Fig. 13) displays on the touch screen showing the machine's name and picture. After a few seconds this screen automatically changes to the "SETTING" screen.

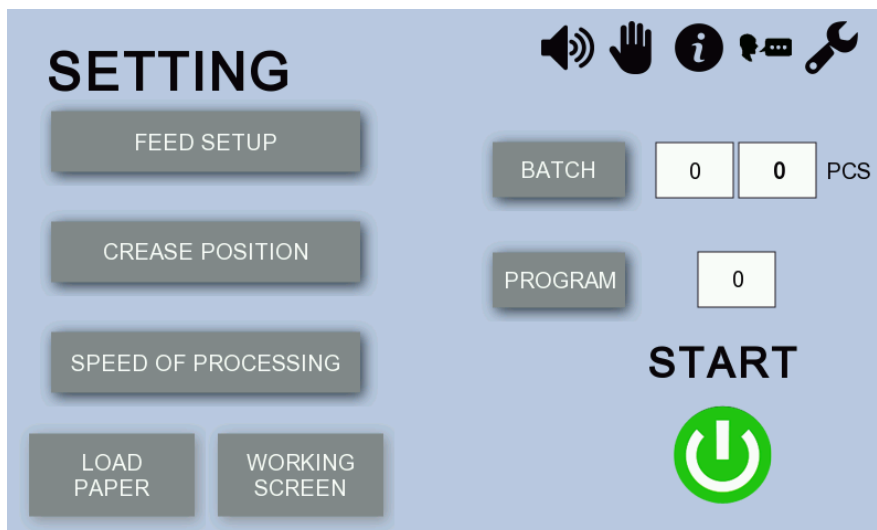





Fig. 14: "SETTING" Screen

8.2 Overview of Touch Screen Function Icons

8.2.1 Sound On/Off

Press  to turn on/off the sound signal for key pressing. If the sound is on, there will be a beep when the active areas on the touch screen are pressed. If the sound is off,  appears.

8.2.2 Manual Control

Press  to display the manual control screen, see Section 8.10.

8.2.3 Info

Press  to display the information screen. The data are approximate. Press **OK** to go back to the “SETTING” screen.

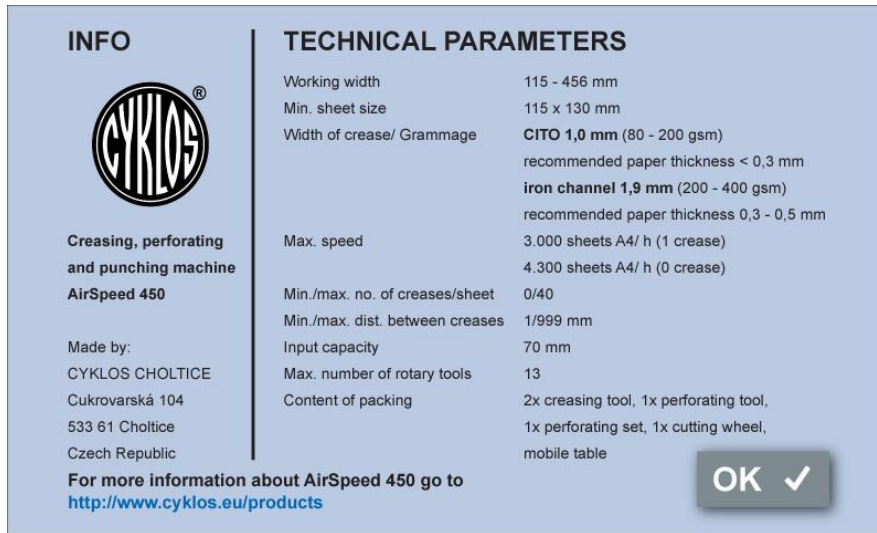

Fig. 15: “INFO” Screen

8.2.4 Language Selection

Press  to display the language selection screen and choose the language.

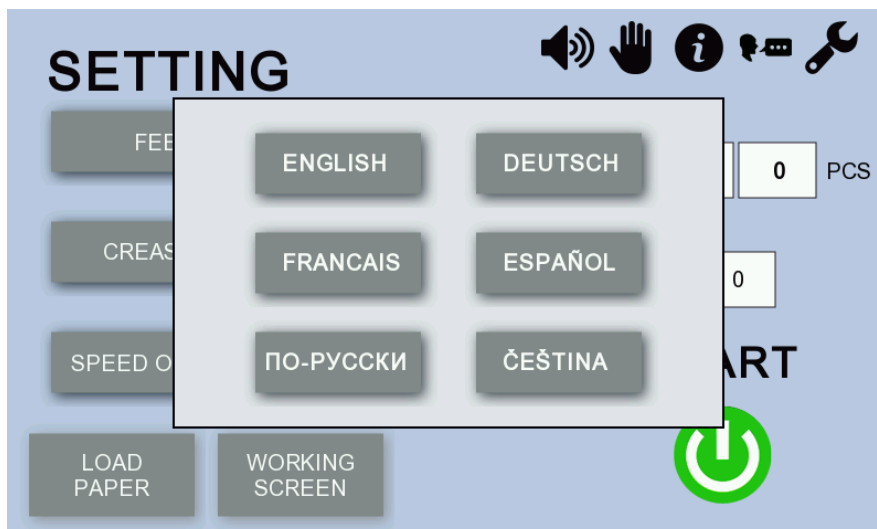



Fig. 16: “LANGUAGES” Screen

8.2.5 Service Menu

Press  to display the “SERVICE MENU” screen. This menu is password-protected and accessible only to the manufacturer’s (distributor’s) service engineers. If you do not know the password, press  to return to the “SETTING” screen (Fig. 17a). Entering the correct password and confirming by **OK** displays the “SERVICE MENU” screen. Press **OK** to go back to the “SETTING” screen.

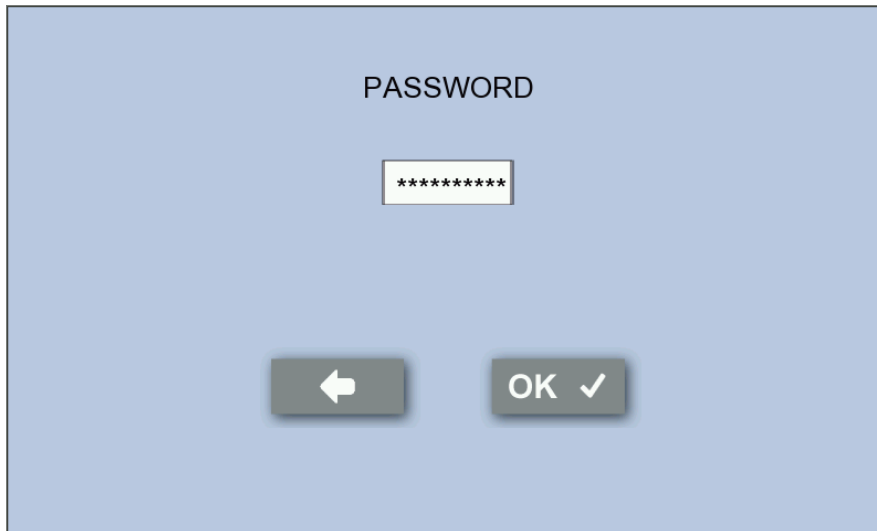

Fig. 17a: “SERVICE MENU” Screen – Password

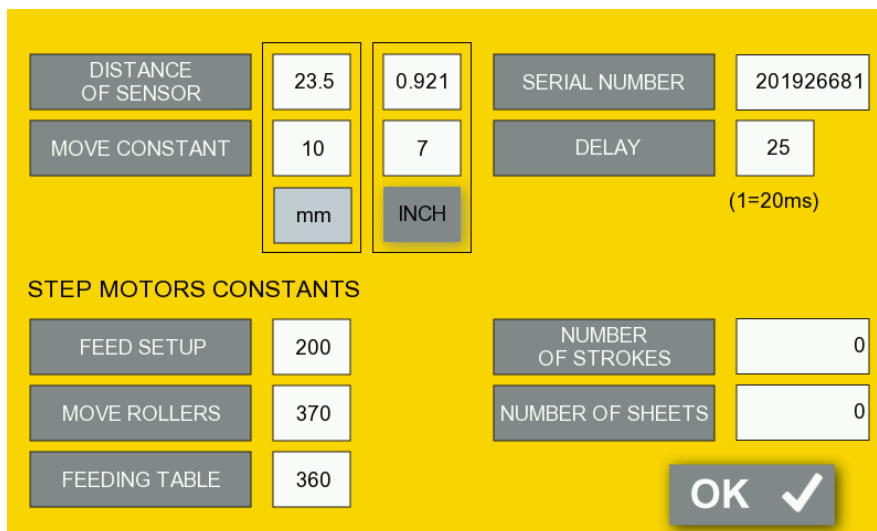

Fig. 17b: “SERVICE MENU” Screen

Note: Description of service screen is not part of this document because this screen is not accessible to end user.

8.3 Setting the Feed

Press **FEEDING** on the “SETTING” screen (Fig. 14) to display the following menu.

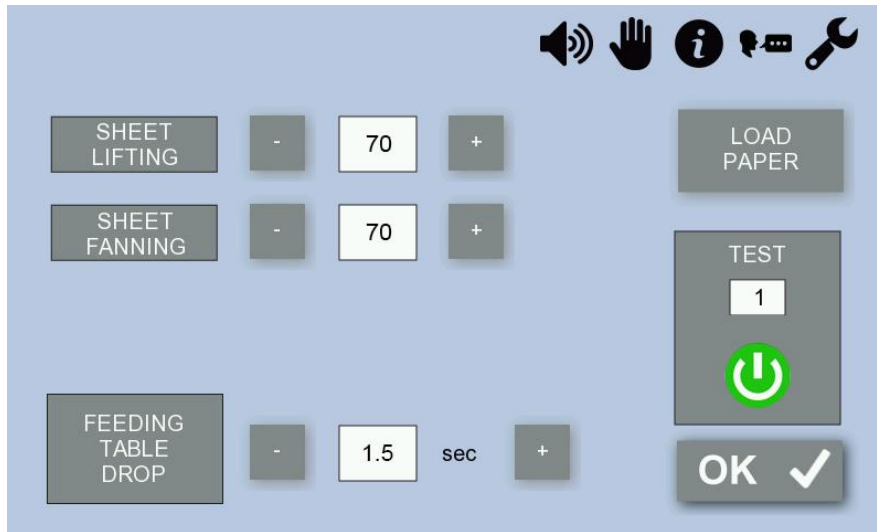





Fig. 18: “FEEDING” Screen

SHEET LIFTING and **SHEET FANNING** values on the display are set to 70/70 by default. By pressing the - and + buttons, change the values in steps of 5 in the range of 50 to 100. In general, the rule is that the smaller the size and the lower the weight of the paper, the smaller the values need to be set.

The numerical field next to the description **FEED TABLE DROP** is used to set the initial drop of the table before the actual start of the work cycle. The time range of the **FEED TABLE DROP** is 1.0 - 2.0 seconds. The default value is 1.5 seconds. After entering the Drop value and pressing **START** , the feed table moves to the upper position and then descends by the entered value (1 s = approx. 8 mm). Set the value of the **FEED TABLE DROP** so that at the beginning of the work cycle there is sufficient aeration and separation of approximately 4 to 10 sheets (according to paper weight).

Now the machine is ready for test paper feed. Press **LOAD PAPER** (functions: press – table moves down; press again – downward move stops). Then start the test by pressing . Use the numeric field over  to enter the number of test sheets if required; the default value is 1. During the test the screen shows the sheets yet to be processed in the test. Multiple-sheet test is recommended.

If paper feed is set incorrectly, the machine switches off automatically during the test and the touch screen displays a red warning **INCORRECT FEEDING**.

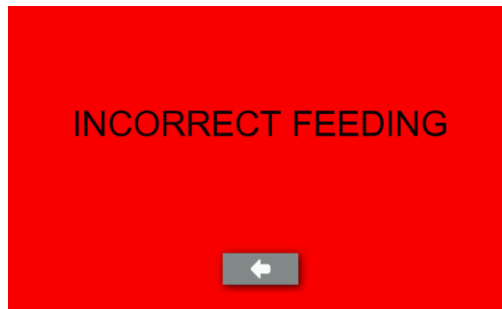

Fig. 18a: “FEEDING” Screen – Incorrect Feeding

In such case fan out the paper better, set again the Side Guides (12) and reset the opening of separator (see Section 7.2), or adjust **SHEET LIFTING** and **SHEET FANNING** manually.

8.4 Setting the Number and Position of Creases/Perforations

Press **CREASE POSITION** on the “SETTING” screen (Fig. 14) to display the following menu.

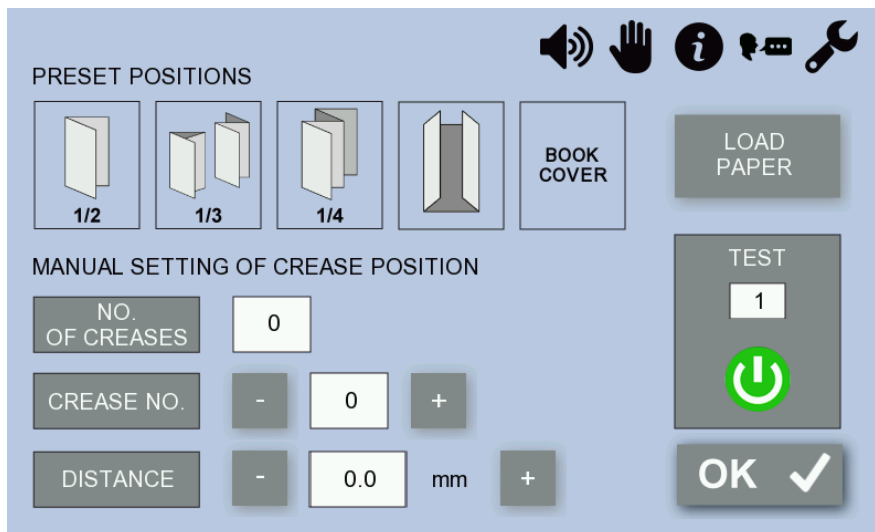

Fig. 19: “CREASE POSITION” Screen

8.4.1 Most Common Folds

The most commonly used folds are created by placing the crease at exactly defined relative distances of 1/2, 1/3 or 1/4 of the paper. The most common creases are easily set by pressing the corresponding button. First, place the required sheet of paper to be creased on the feeding table. Then press **1/2** (proceed similarly for other types of fold). A single sheet is run through the machine without creasing; the machine measures the sheet and saves the sheet length in the memory. Values are displayed in their respective fields when the sheet has passed through. Then start the test by pressing . Use the field over to enter the number of test sheets if required; the default value is 1. During the test the screen shows the sheets yet to be processed in the test. Once the test is completed, it is recommended to check the measured length before processing the rest of the batch. If the crease is not precisely at the required distance, correct the distance manually. Then press **OK** to return to the “SETTING” screen (Fig. 14) and press **START** to run the working process.

8.4.2 Setting the Number of Segments

Press the numeric icon next to the **NO. OF CREASES** field on the touch screen to display the numeric keypad (Fig. 20). By pressing the relevant digit, the number of crease/perforation/punch lines (segments) is set. You can set as many as 0 – 40 segments. Setting 0 makes the paper just pass through the machine. This may be suitable if you wish to use only rotary tools (perforating or cutting), see Section 8.10.1. Selection of the number of segments is ended by pressing the **ENTER** key. The number of segments is now set.

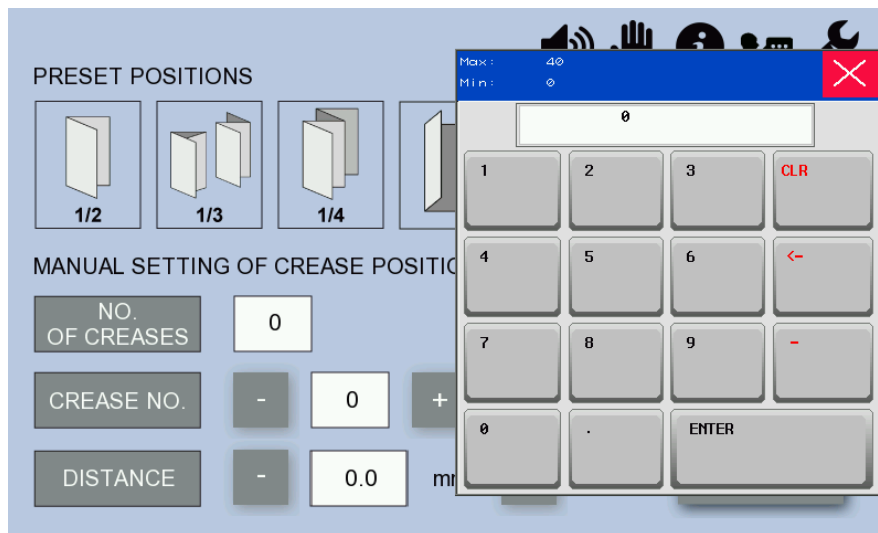



Fig. 20: Numeric Keypad Screen

8.4.3 Setting the Position of Segments

The position of the first segment is set as the distance from the edge of the sheet. The position of each following segment is defined as its distance from the previous segment. Use the **+** and **-** keys to choose the required segment. Select 1 in the numeric field next to **CREASE NO.** and this activates the **DISTANCE** numeric icon. A numeric keypad is now displayed. Use the numeric keypad to set the distance from the edge of the sheet and press **ENTER**. The position of the first segment is set. Using the **+** key choose segment number 2 and then press the numeric icon under **DISTANCE** again. Use the numeric keypad to set the distance from the first segment and press **ENTER**. The second segment is set. Set all the remaining segments in the same way. Press  to run a test after you have set all segments.

8.5 Setting the Speed of Processing

Press **SPEED OF PROCESSING** on the “SETTING” screen (Fig. 14) to display the following menu.

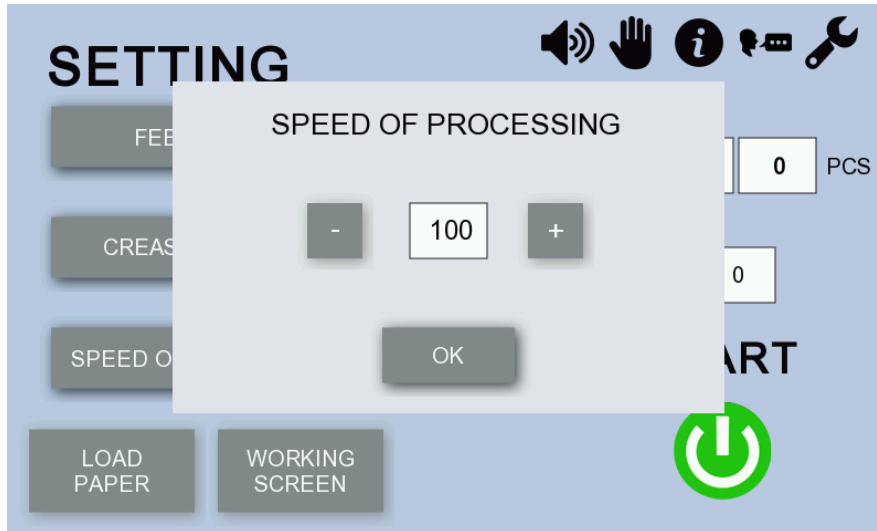

Fig. 21: “SPEED OF PROCESSING” Screen

Change speed by using the **+** and **-** keys. Minimum and maximum values: 50 and 100, respectively. The default value is 100, which means 100% speed of the machine (3,000 A4 sheets per hour). The maximum speed can be reduced by half. Low speeds are suitable for processing papers complicated to feed or using multiple rotary tools on the shaft. When you have finished the setting, press **OK** to confirm.

8.6 Loading Paper

To load paper press **LOAD PAPER** (functions: press – table moves down; press again – downward move stops). Identical button with same functionality is also available for screens “FEEDING”, “CREASE POSITION” and “WORKING CYCLE”.



8.7 Setting Batch

Press the numeric icon next to the field **BATCH** on the “SETTING” screen (Fig. 14) to display numeric keypad (Fig. 22).

8.7.1 Total Batch

Press numerical icon under **TOTAL** to set the batch quantity = the number of sheets to be processed by the machine in a single cycle. Use numeric calculator and press **ENTER** to confirm. Enter **0** if you wish to switch the batch off. Go back to the “SETTING” screen by pressing OK.

Batch processing may be interrupted in three ways:

1. The machine is stopped by pressing the **STOP** button  on the touch screen. The touch screen shows both the total batch and the number of sheets already processed. When you restart the machine by pressing the **START** button , the machine goes on to process the remaining sheets in the batch.

2. Press **STOP** (2) to stop the machine. The touch screen shows only the total batch and the value showing the number sheets already processed in the batch is reset to zero. If you press the **START** button  to restart the machine, the machine processes the batch from the beginning.
3. The machine is switched off using the electric switch (4), or by disconnecting the power supply. When the machine is switched on again, the batch is not displayed and must be entered anew.

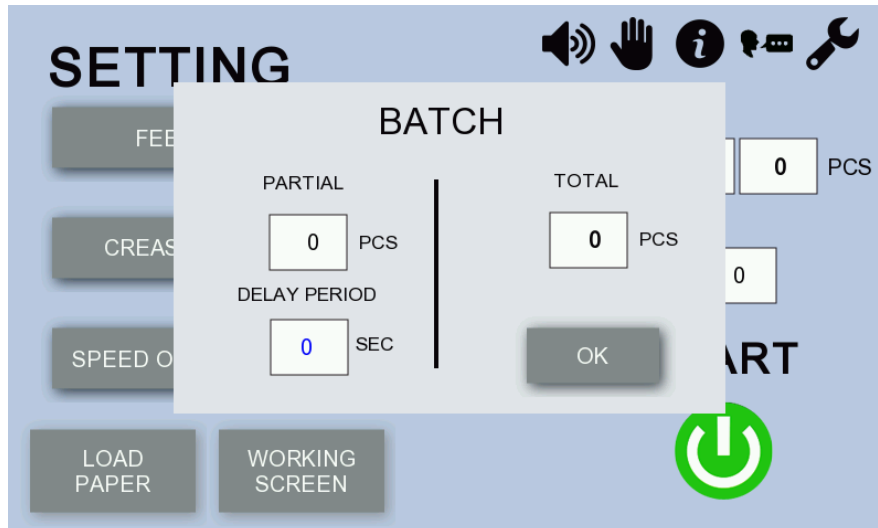

Fig. 22: “BATCH SETTING” Screen

8.7.2 Partial Batch

The purpose of partial batch is to divide the primary (total) batch into a desired amount of secondary (partial) batches. After inputting the amount of required pieces into the field below **PARTIAL** and then the required time delay period in seconds, the machine then starts its process pausing for the set delay period given in between the partial batch quantity, continuously up until the end of the total batch quantity. This mode is useful mostly for calendar makers. The operator sets total batch (e.g. 500 pcs) and partial batch (13 pcs) with delay 5 seconds enabling him to take away each 13 processed batch of sheets.

8.8 Program Saving and Loading

The software allows saving 60 different programs. Both the values set on the “CREASE POSITION” screen and those set on the “FEEDING” screen are saved under a program number. Once the feeding and crease position values are set following the instructions in Sections 8.3 and 8.4, you can go on to save the program. Press the key **PROGRAM** on the “SETTING” screen (Fig. 14). The program saving and loading menu (Fig. 23) is displayed. Use the + and - keys to list values between **0** and **60**. You can save your jobs under **1 – 60**; value **0** indicates no program is saved in the memory.

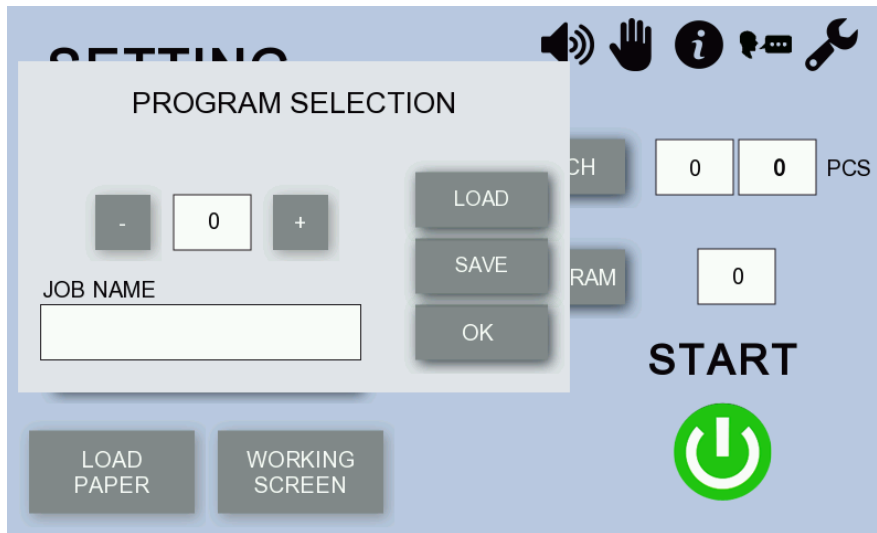



Fig. 23: “PROGRAM SAVING AND LOADING” Screen

Press **SAVE** if you have your job ready and wish to save it. In the **JOB NAME** field you may enter up to 24 characters to name the program you wish to save. The field changes along with the program number. Press **OK** to go back to the “SETTING” screen. The program is saved and displayed on the “SETTING” screen. Load the program in a similar manner. Use **+** and **-** to choose a saved program you wish to load. Press **LOAD**. Press **OK** to go back to the “SETTING” screen. The number of the loaded program is displayed next to the **PROGRAM** field. The machine is ready to operate according to this program.

Warning: The touch screen displays the number of the last program saved or loaded. For the sake of effectiveness, the operator can change this program by a different program without saving it. In such case, the number of the last program saved or loaded is still displayed, but the machine operates according to the operator’s last setting, even though this setting has not been saved. If the machine is turned off and then turned on again by the electric switch, the machine operates according to the program displayed on the touch screen. The last unsaved setting is deleted.

8.9 Starting Working Cycle

Adjust the feeding table (11) according to the instructions in Section 7.1. There must be a minimum gap between the side guides and the pile of paper. The machine’s design allows loading a pile of paper of up to 70 mm in height. Adjust the distance of the back stop (5) on the delivery table (7) according to the size of the sheet. Press **START**  on the touch screen (Fig. 14). The machine starts running and the touch screen switches to the “WORKING CYCLE” screen (Fig. 24). The **STOP** icon  and information about the program, the batch (partial and total) and the number of processed sheets are displayed on the touch screen.

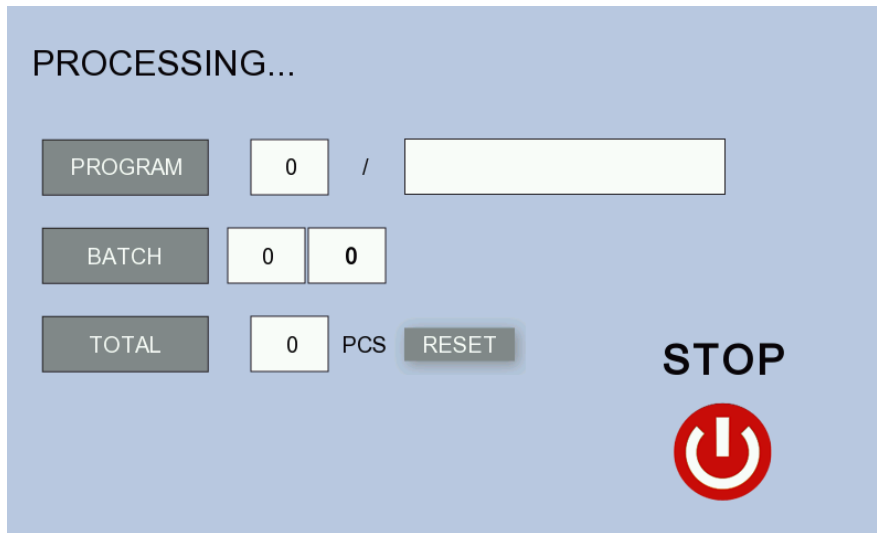



Fig. 24: "WORKING CYCLE" Screen

The feeding head starts feeding sheets of paper into the machine. Do not load another pile of paper onto the feeding table until the machine has processed the last paper, which automatically ends the working cycle and the "WORKING CYCLE" screen is displayed (Fig. 25). The working cycle can be interrupted manually by pressing **STOP** . In case of emergency the machine can be switched off with the big red **STOP** button (2) on the left side of the touch screen.

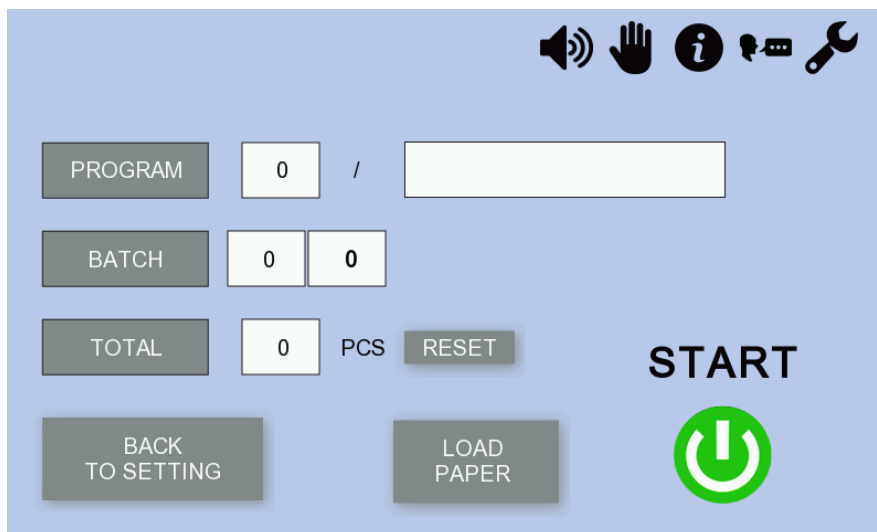













Fig. 25: Working Screen

8.9.1 Working Screen

After processing the job or after interruption of the job by operator "WORKING SCREEN" (Fig. 25) remains on the display. It is also possible to enter "WORKING SCREEN" anytime directly from the "SETTING" screen. This screen includes the same information as "WORKING CYCLE" plus buttons **LOAD PAPER** and **BACK TO SETTING**. If the processing runs as you wish and you want to continue the job, press **LOAD PAPER** and replenish paper on the front table and press icon **START** . If you need to correct the job, press **BACK TO SETTING**.

*Note: It is possible to **RESET** number of processed sheets in the “WORKING CYCLE” prior to the start of the process. The machine starts to count sheets from zero. The same option is included in “WORKING SCREEN”.*

8.10 Manual Control

Manual control is mostly used when replacing the tools or when loosening jammed paper from the machine. Press  (manual control) on the “SETTING” screen (Fig. 14) and the following menu is displayed (Fig. 26). Press the move forward/backward icons ,  next to the **MOVE ROLLERS** field to set the machine’s rollers running. Icons  and  define the continuity of the run of the rollers.  – rollers are turning only if the arrow is held.  – rollers start running and rotate until the icon is pressed again. The **FEED BELTS** (feeding strips running) and **FEEDING TABLE** fields work similarly. Press **SHEET LIFTING** and **SHEET FANNING** to run the respective functions. Use  (tool backwards) under the **UPPER TOOL** field if the perforation/creasing force gets too high and the top bar (23) remains in the lower position. Press  to unlock the tool and adjust the thrust by using the tool thrust regulation screws (20). Activate  (tool forwards) to make a trial stroke. Refer to Section 7.6 for how to use the icons of the **UPPER TOOL** field. Press **OK** to go back to the “SETTING” screen.

8.10.1 Rotary Perforating, Cutting

Press **ROTARY PERF SETUP** to feed paper up to the perforating wheels; the key changes to **PAPER OUT**. The screen is inactive while the paper is being fed up to the perforating wheels. The key becomes active for pressing when the paper has stopped. However, first you need to set the pulleys on the shaft and perforating/cutting knives (30) into the required position according the ruler (16) and the graphics on the paper you process, see Section 7.3 Then press **PAPER OUT**, the paper is moved out onto the delivery table and the key changes back to **ROTARY PERF SETUP**.

If you wish to run only the rotary perforating (cutting), enter **0** next to **NO. OF CREASES**. For setting the rotary tools refer to Section 7.3

8.10.2 TriFold 360 Connection

Use **TRIFOLD 360 CONNECTION** key to align and connect AirSpeed 450 with folding unit Cyklos TriFold 360. After pressing the key, one sheet of paper is fed through the machine until its front edge stops about 7 cm behind the exit of the machine. The key changes to **PAPER OUT**. This position of the sheet allows the operator to level the height of TriFold 360 with the height of the creaser and to join both machines properly. Also it allows to align the side guide with sensor of TriFold 360 with the sheet (see TriFold 360 user manual). When ready, press **PAPER OUT**, and the paper is moved out onto the transport belts of TriFold 360 and the key changes back to **TRIFOLD 360 CONNECTION**.

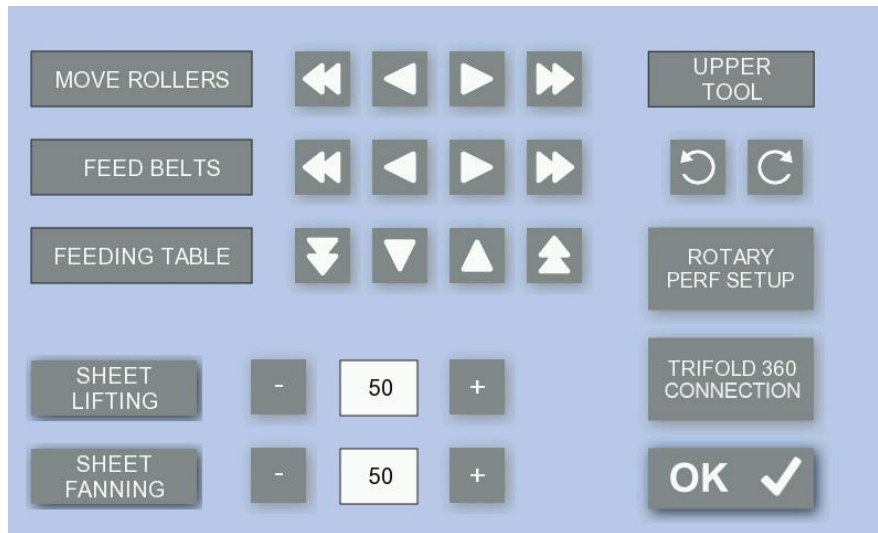

Fig. 26: "MANUAL CONTROL" Screen

9. RECOMMENDED MACHINE MAINTENANCE

Clean dust from the machine after each job using, for example, compressed air.

Grease the bearings (positions 21 and 24) with bearing grease annually.

10. MACHINE DISPOSAL

After the end of the service life, it is forbidden to dispose of the machine in the municipal waste. The machine must be disassembled, and metallic, non-metallic, plastic, rubber and electronic parts sorted. These parts are disposed of at the relevant points of recycling. Some parts of the machine can contain hazardous substances that are harmful to the environment and health.

APPENDIX 1: ACCESSORIES

571 40 467	Creasing Tool (CITO channel 1.0 mm)	1 x
571 40 466	Creasing Tool – “Iron Channel” 1.9 mm	1 x
571 40 465a	Perforating tool 2:1	1 x



A perforating tool (571 40 465a) is fitted in the machine for transit. Creasing Tool CITO 1.0 mm (571 40 467) and Creasing Tool – “Iron Channel” 1.9 mm (571 40 466) are kept in the waste drawer (1).



Note: The tools for GPM 450 SPEED and AirSpeed 450 are identical. As AirSpeed 450 is wider, a small metal-sheet extension needs to be fitted on this tool; the extension is kept in the waste drawer, see the picture.

572 59 813

Front stop (43a)

1 x



572 59 228

Narrow front stop (43b)

2 x



572 59 814

Additional Side Guide (37)

2 x



572 59 815
572 59 838

Upper Guide (42a)
Horní Guide – Ultrasound Sensor (42b)

3 x
1 x

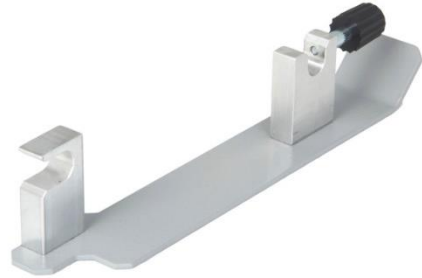
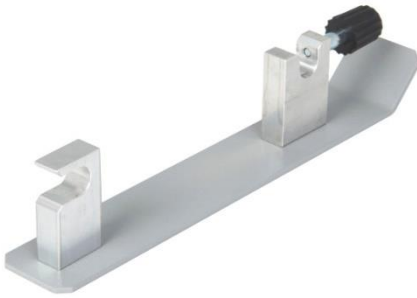

572 59 163

Rear side guide (6)

2 x



572 59 162

Back stop (5)

1 x

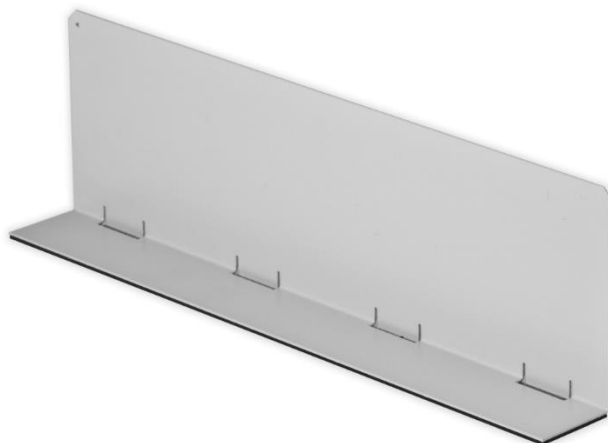

572 59 177

Levelling strip (14)

4 x



413 00 007/0

Allen key no. 2

1 x

413 00 014/0

Allen key no. 4

1 x

413 00 016/0

Allen key no. 8

1 x

413 00 018/0

Wrench no. 17

1 x

413 00 019/0

Cross screwdriver no. 2

1 x

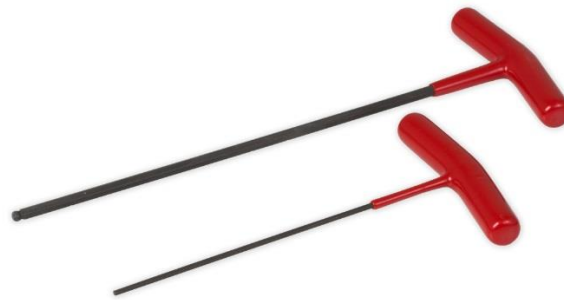

345 00 226/0

Power cable

1 x



APPENDIX 2: TABLE ASSEMBLING INSTRUCTIONS

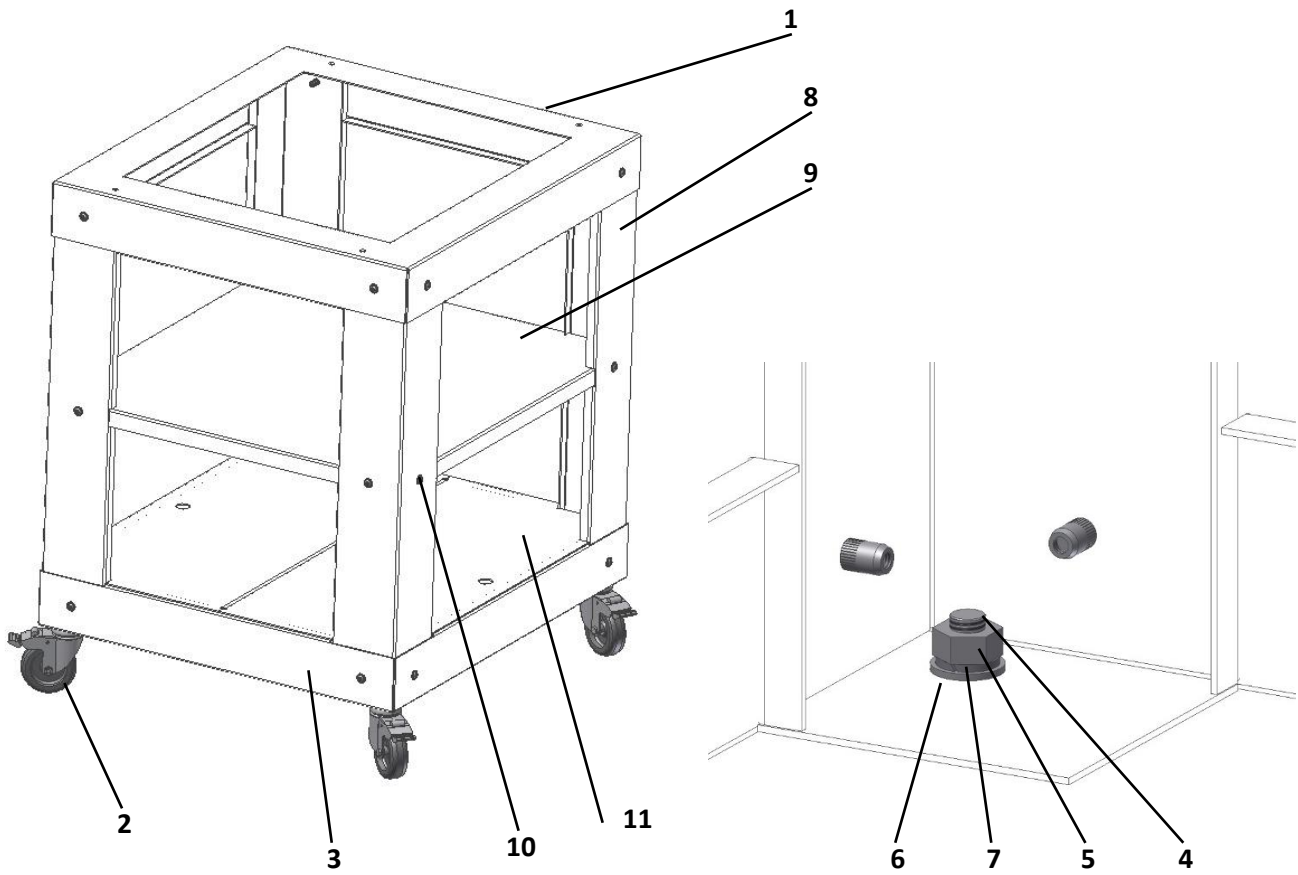

POSITION	PCS	DESCRIPTION
1	1	BASE
2	4	WHEEL WITH BRAKE
3	1	BOTTOM BASE
4	4	SCREW M10x25
5	4	NUT M10
6	4	WASHER 10.5
7	4	SPRING WASHER 10
8	4	STAND-FRAME ASSEMBLY
9	1	SHELF ASSEMBLY
10	24	SCREW M6x14
11	2	COVERING PLATE

APPENDIX 3: OPTIONAL ACCESSORY

3.1 Strike Tools

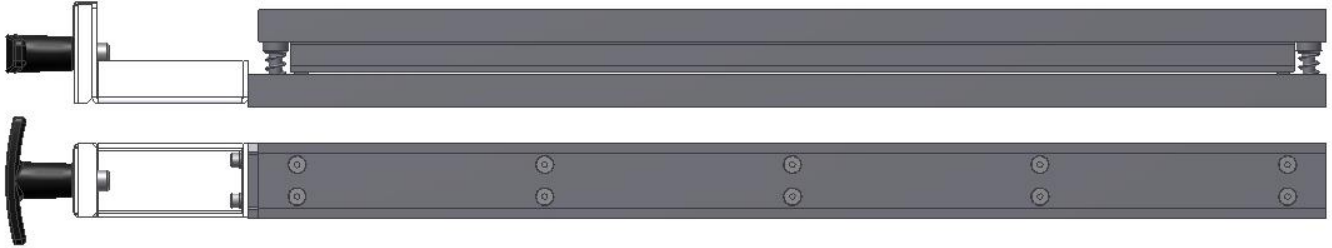

1. *Microperforating tool 30 TPI (571 40 464)*
2. *Cutting tool (571 40 551)*
3. *Partial perforating tool (571 40 571)* - - - - -
4. *Punching tool for wire binding – square 4 x 4 mm, 3:1 (571 40 462)*



5. *Punching tool for wire binding – square 5 x 5 mm, 2:1 (571 40 529)*



6. *Punching tool for wire binding – square 6 x 6 mm, 2:1 (571 40 593)*



7. *Punching tool for wire binding – round, diameter 4 mm, 3:1 (571 40 475)*



8. *Punching tool with calendar semi-circle – square 4 x 4, 3:1 (571 40 463)*



9. *Punching tool with calendar semi-circle – round, diameter 4 mm, 3:1 (571 40 476)*



10. *Punching tool for coil binding – oval 4 x 5 mm, 4:1, 6,3 mm (571 40 594)*



11. *Euro Punch tool (571 40 506)*

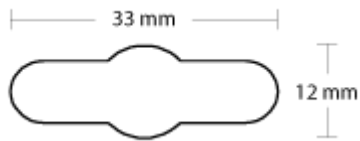

3.1.1 Removing Punching Tool Pins

Except for the Euro Punch, all the punching tools specified above have removable pins. To remove the pins, loosen the 10 screws on the upper edge of the tool and remove the bar under the screws. After you have removed the bar, use pliers to take each pin out. Then put the bar back in the original position and replace the screws.

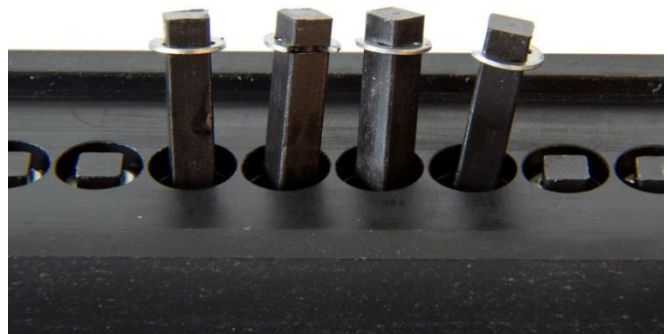

Note: For technological reasons, each machine tool features two pin types of different lengths (the approximate length difference is 0.5 mm). When you have removed the pins, make sure you mark which pin is fitted in which hole so that you can fit the pins back in the correct holes. If you fit a pin in the wrong hole, the passage of the pin through the paper may become impaired.

3.2 Rotary Tools

You can fit as many as 13 rotary tools on the shaft (28) at the machine output.

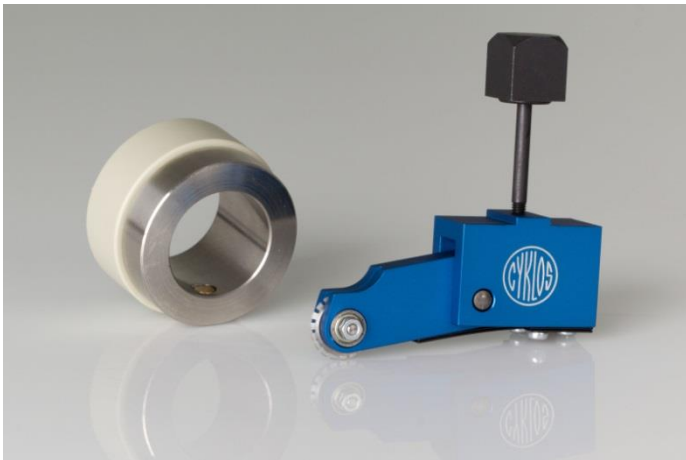

572 59 270 Complete perforating kit

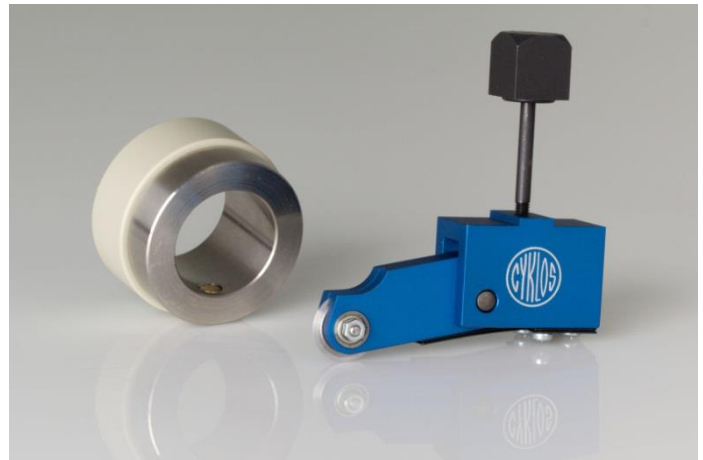

572 59 271 Complete cutting kit

Note: 1x complete perforating kit (572 59 570) and 1x cutting wheel (572 75 916) come as part of the standard equipment.



572 59 433 Complete microperforating kit (30 TPI) – optional (or microperforating wheel only – 572 85 108)

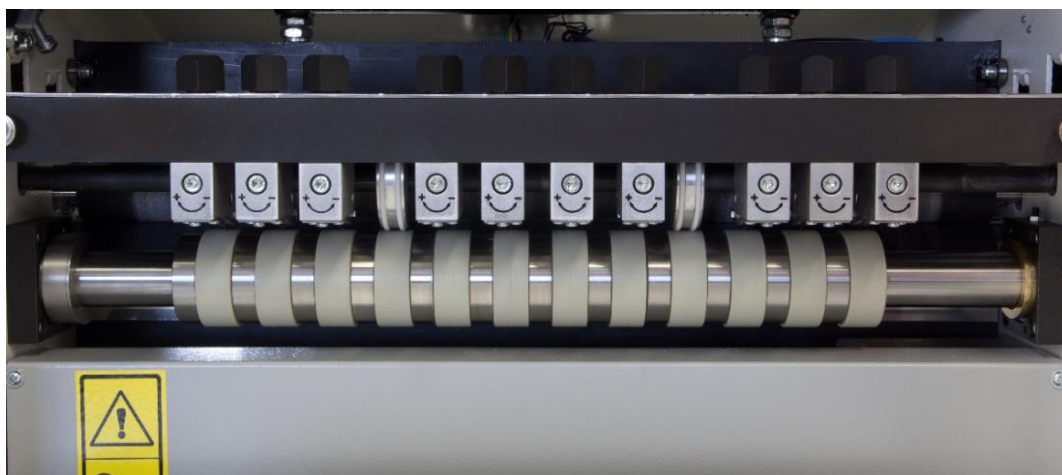

10 perforating kits fitted (max 13)

APPENDIX 4: ULTRASOUND SET FOR DOUBLE SHEET DETECTION

Starting from serial number **201926663** there is an option to purchase Ultrasound Set for detection of double sheets. Installation of this set is not part of this document. After purchasing the item, you'll receive a separate manual with description of its installation and functionality.

Note: Installation must be arranged by skilled service technician.



572 59 600 Ultrasound Set for Double Sheet Detection



APPENDIX 5: THE MOST COMMON FAULTS (TROUBLESHOOTING)

1) Error screen – PAPER NOT LOADED

After pressing **START key**  the red screen with warning sign **PAPER NOT LOADED** appears. It shows up if the sensor in the feeding tray doesn't detect the paper. The paper is either missing completely, or there is a dark or even solid black section paper loaded. Placing one sheet of white or light paper on the top of the pile will resolve the issue.



2) Error screen – SENSOR BLOCKED

After pressing **START key**  the red screen with warning sign **SENSOR BLOCKED** appears. This situation can usually happen after the releasing or unblocking of jammed paper from the machine. While removing the sheet a fragment of paper might stay inside the machine blocking the signal between transmitter and receiver of the sensor. Remove the piece of paper from the sensor (use compressed air blower if possible), this will resolve the issue. After pressing **START key**  again the error screen will not show up again.

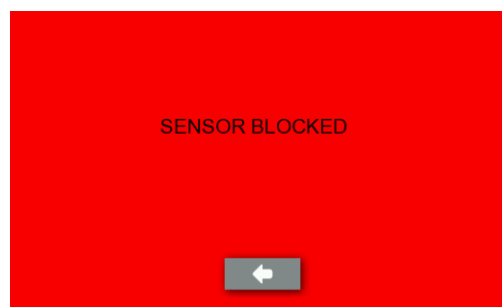

3) Paper jam

- Paper can be released using the "Forward" and "Backward" manual control functions – Section 8.10
- If this does not help, take out the exchangeable tool (17) and try to release the paper again using the "Forward" and "Backward" keys.

4) Uneven perforation (creasing)

- See Section 7.5 Adjustment of top bar stroke.

5) Keys on the touch screen unit not working

- Reset the machine (turn it off and then on again).

6) Machine does not feed paper or feeds multiple sheets

- Check the separator setting (Section 7.2)
- Check the **SHEET LIFTING** and **SHEET FANNING** settings (Section 8.3)
- This fault may be caused by a static charge, which keeps the sheets stuck together. Fan out the sheet pile properly (ideally using an air hose).

If the problem persists, please ask you dealer for assistance.